

mp

Professional

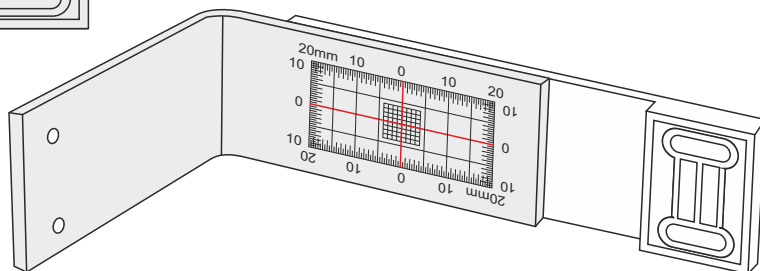
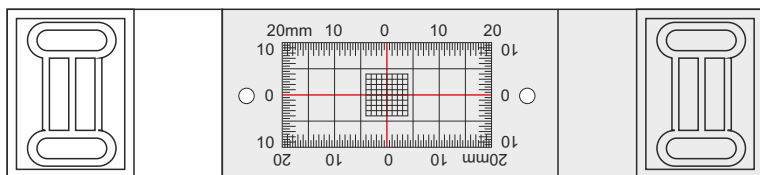

costruzioni misure metriche

www.metroplast.it

LIVELLE - LEVELS - NIVEAUX

min. per modello/per misura - min. per type/per size - min. par type/par mesure
 contributo per impianto - share in mould costs - contribution par moule



Livelle Appendibili
 Hangable Levels
 avec Accrochage



ETICHETTA PERSONALIZZATA
 CUSTOM LABEL
 ETIQUETTE PERSONALISÉ

min	€	Promo	€
20	0,15	100	0,10

10 061 - SILVER PRO 3

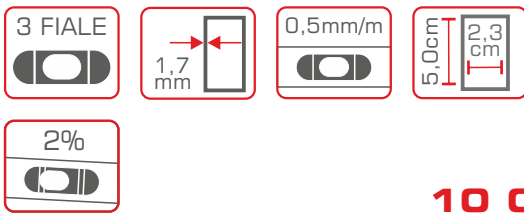

Art.	cm	↕	€
10 061 03	30	10	
10 061 04	40	10	
10 061 05	50	10	
10 061 06	60	10	
10 061 08	80	10	
10 061 10	100	10	

10 060 - SILVER PRO 2

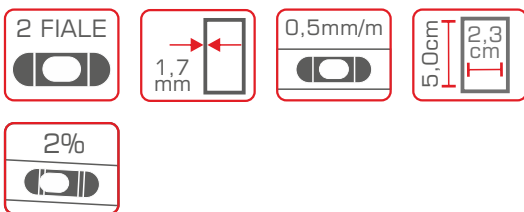

Art.	cm	↕	€
10 060 03	30	10	
10 060 04	40	10	
10 060 05	50	10	
10 060 06	60	10	
10 060 08	80	10	
10 060 10	100	10	

10 085 - SILVER PRO MAGNETIC

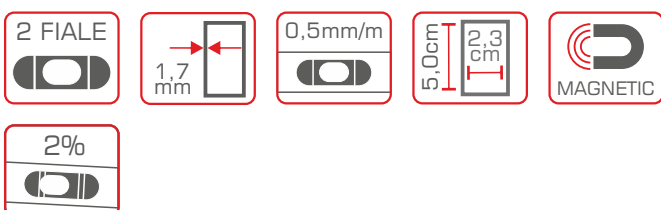

Art.	cm	↕	€
10 085 04	40	10	
10 085 05	50	10	
10 085 06	60	10	
10 085 08	80	10	
10 085 10	100	10	

LIVELLE - LEVELS - NIVEAUX

10 070 - BLACK LEVEL

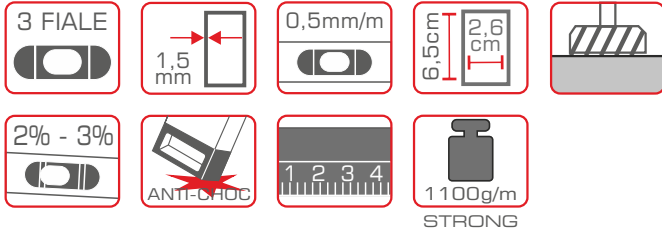
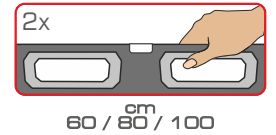
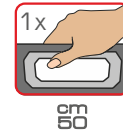

Art.	cm		€
10 070 04	40	10	
10 070 05	50	10	
10 070 06	60	10	
10 070 08	80	10	
10 070 10	100	10	

10 071 - BLACK MAGNETIC

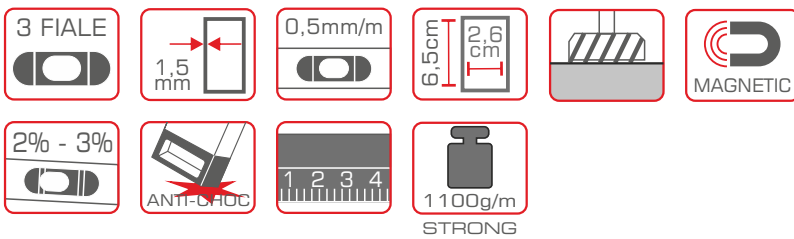

Art.	cm		€
10 071 05	50	10	

10 083 - RED LEVEL

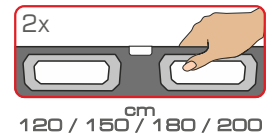

Art.	cm		€
10 083 04	40	10	
10 083 05	50	10	
10 083 06	60	10	
10 083 08	80	10	
10 083 10	100	10	
10 083 12	120	10	
10 083 18	180	10	
10 083 20	200	10	

10 079 - RED MAGNETIC



Art.	cm		€
10 079 04	40	10	
10 079 05	50	10	
10 079 06	60	10	
10 079 08	80	10	
10 079 10	100	10	

LIVELLE - LEVELS - NIVEAUX

10 076 - TOP LEVEL



Art.	cm		€
10 076 04	40	10	
10 076 05	50	10	
10 076 06	60	10	
10 076 08	80	10	
10 076 10	100	10	

10 075 - TOP MAGNETIC



Art.	cm		€
10 075 04	40	10	
10 075 05	50	10	
10 075 06	60	10	
10 075 08	80	10	
10 075 10	100	10	

10 084 - DIE-CAST

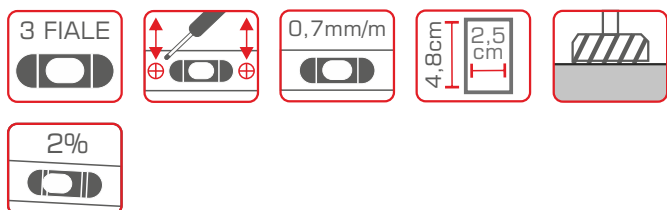

Art.	cm		€
10 084 04	40	10	
10 084 05	50	10	
10 084 06	60	10	

10 077 - ECO LEVEL



Art.	cm		€
10 077 03	30	10	
10 077 04	40	10	
10 077 05	50	10	
10 077 06	60	10	
10 077 08	80	10	

LIVELLE - LEVELS - NIVEAUX

10 088 - HOBBY



FRONTAL
Lettura Frontale
Frontal View
Lecture Frontale



UPPER
Lettura dall'Alto
Upper View
Lecture d'en Haut



Art.	cm		€
10 088 00	22	25	

10 089 - MINI



10 089 01



10 089 02



FRONTAL
Lettura Frontale
Frontal View
Lecture Frontale



UPPER
Lettura dall'Alto
Upper View
Lecture d'en Haut

Art.	cm		€
10 089 01	○ 10,5	10	
10 089 02	● 10,5	10	

10 086 - ACQUA



Art.	cm		€
10 086 00	18x3	10	

10 086 - KIT ACQUA



Art.	m		€
10 086 01	12	10	
10 086 05	25	10	

10 086 - TUBO



Art.	m		€
10 086 25	25	10	

SQUADRE - TRY SQUARE - EQUERRE

11 077 - SQUADRA

Squadra per Carpentiere
Carpenter's Try Square
Equerre pour Charpentier

Acciaio
Steel
Acier



Pezzo Unico Tagliato a Laser
Single Piece Laser Cut
Une Pièce Coupé au Laser

30x5 mm Sezione
mm Section

Art.	mm		€
11 077 04	400	5	
11 077 05	500	5	
11 077 06	600	5	
11 077 08	800	5	
11 077 10	1000	5	

11 070 - SQUADRA ECO

Squadra per Falegname
Try Square
Equerre



Art.	mm		€
11 070 25	250	12	
11 070 30	300	12	
11 070 35	350	12	
11 070 40	400	12	

11 079 - ANGLE

Squadra Duralluminio
Try-square Duralumin
Equerre Duralumin

Fissaggio a Vite
Fixing Screw
Fixation à Vis

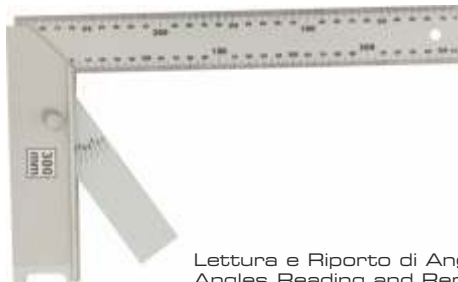

Base con Piastra Graduata
Base with Graduate Plate
Base avec Plaque Graduée

Lettura e Riporto di Angoli
Angles Reading and Reporting
Lire ou Reporter les Angles

Art.	mm		€
11 079 40	400	5	

11 078 - DURAL

Squadra Duralluminio
Try-square Duralumin
Equerre Duralumin



Modello Pesante
Heavy Type
Modèle Lourd

Art.	mm		€
11 078 05	500	10	

SQUADRE - TRY SQUARE - EQUERRE

11 075 - 8 IN 1

Squadra Pieghevole
Folding Square
Equerre Pliant

8 Posizioni
Positions
Positions



Alluminio e Acciaio
Aluminium and Steel
Aluminium et Acier

Art.	cm	cm		€
11 075 20	20	8	1	
11 075 30	30	12	1	
11 075 40	40	15	1	

11 080 - MULTI

Squadra Multi-Angoli
Multi-Angles Square
Equerre Multi-Angles



dispositivo graduato con scala di inclinazione 15°
graduated device with inclination scale 15°
dispositif gradué avec gamme d'inclination 15°

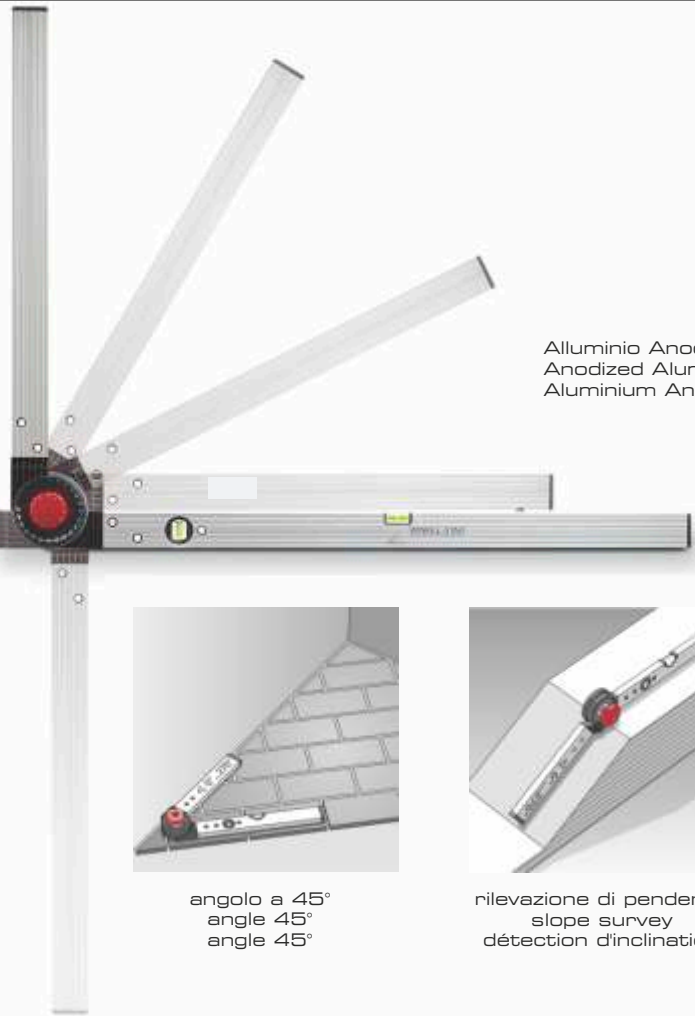

Alluminio Anodizzato
Anodized Aluminium
Aluminium Anodisé



angolo esterno a 90°
external angle 90°
angle externe 90°

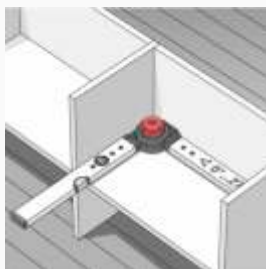

angolo interno a 90°
internal angle 90°
angle interne 90°

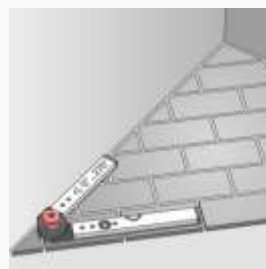

angolo a 45°
angle 45°
angle 45°

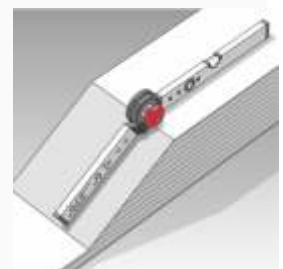

rilevazione di pendenze
slope survey
détection d'inclination

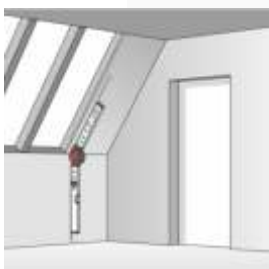

riporto di misurazioni
transfer of measurement
rapport de mesures

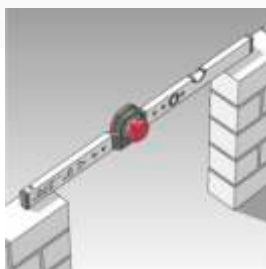

utilizzo come livella
usable as a level
utilisabile comme niveau

Riporto o misurazione da 0° a 270°
Angles measurement or report from 0° to 270°
Rapport ou mesure des angles de 0° à 270°

Art.	cm	cm		€
11 080 04	40	30	1	
11 080 08	80	60	1	
11 080 12	120	60	1	

PISTOLE SILICONE - CAULKING GUN - PISTOLET SILICONE

840 08 - TOP GUN

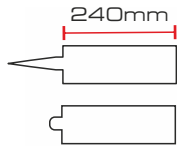

Meccanismo Rinforzato
Reinforced Mechanism
Mécanisme Renforcé



Metallo Fissato a Dado
Nut Fixing Metal
Métal Serré à Écrou

Art. 15 840 08 g 850 6 €

840 05 - STRONG GUN

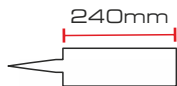

Rinforzo in Metallo
Metal Reinforced
Renfort en Métal



Saldatura a Filo Continuo
Continuous Wire Welding
Soudage à Fil Continu

Art. 15 840 05 g 700 10 €

840 09 - HEAVY GUN

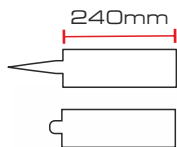

Metallo Fissato a Vite
Screw Fixing Metal
Métal Serré à Vis



Regolazione Pressione
Pressure Adjustment
Réglage de la Pression

Art. 15 840 09 g 1050 6 €

PISTOLE SILICONE - CAULKING GUN - PISTOLET SILICONE

840 02 - CLASSIC GUN

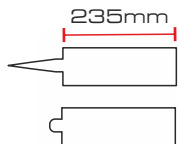

Meccanismo Rinforzato
Reinforced Mechanism
Mécanisme Renforcé

Art.	g		€
15 840 02	650	10	

840 04 - SQUELETTE



Leva in Acciaio
Steel Lever
Lever en Acier

Art.	g		€
15 840 04	400	10	

840 07 - ALU GUN

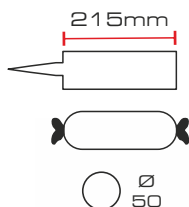

Profilo Robusto
Strong Section
Profile Robuste

Art.	g		€
15 840 07	700	10	

PISTOLE SILICONE - CAULKING GUN - PISTOLET SILICONE

842 02 - FOAM GUN RED

per Schiuma
Foam Gun
pour Mousse



STRONG

Leggera e Robusta
Light and Strong
Léger et Robuste



TEFLON

Rivestimento Interno in Teflon
Internal Teflon Coating
Revêtement Interne en Teflon



Art.	g		€
15 842 02	250	6	

842 03 - FOAM GUN BLACK

per Schiuma
Foam Gun
pour Mousse



ERGO - GRIP

Ergonomica - Antiscivolo
Ergonomic - Skid-Proof
Ergonomique - Anti-Dérapant



TEFLON

Rivestimento Interno ed Esterno in Teflon
Internal and External Teflon Coating
Revêtement Interne et Externe en Teflon



Art.	g		€
15 842 03	300	6	

842 01 - FOAM GUN SILVER

per Schiuma
Foam Gun
pour Mousse



Art.	g		€
15 842 01	420	6	

PISTOLE SILICONE - CAULKING GUN - PISTOLET SILICONE

841 01 - RESINA

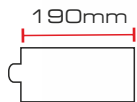

per Resina
Injection Anchor
pour Résine

Art. 15 841 01 g 1100 5 €

840 01 - BASE GUN

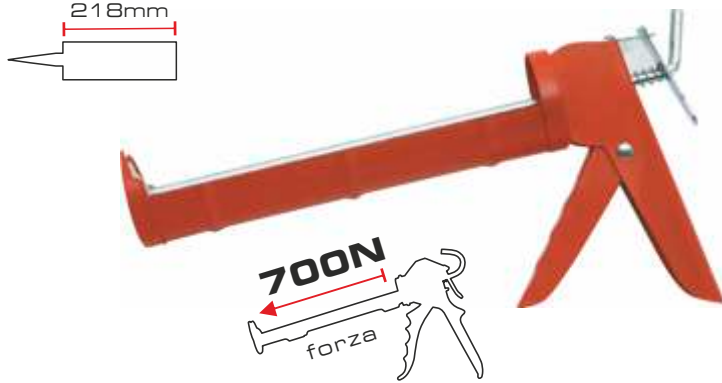
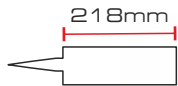

Art. 15 840 01 g 450 12 €

24 050 - AIR PUMP



Art. 24 050 01 g 10 10 €

PERSONALIZZAZIONE - CUSTOMIZATION - PERSONNALISATION



ETICHETTA sul PRODOTTO
LABEL on the PRODUCT
ETIQUETTE sur PRODUIT

min € Promo €
20 0,20 60 0,10

FESSURIMETRI - CRACK MONITOR - FISSUROMETRES

PER IL MONITORAGGIO DI CREPE E FESSURE
TO MONITOR CRACKS AND FISSURES
POUR LA SURVEILLANCE DES FISSURES



CONFEZIONI - PACKAGING - EMBALLAGE



Blister



Scatola
Box
Boîte

PERSONALIZZAZIONE CUSTOMIZATION PERSONNALISATION

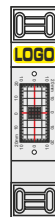

ETICHETTA PERSONALIZZATA
CUSTOM LABEL
ETIQUETTE PERSONNALISÉ

min € 20 **0,15** Promo € 100 **0,10**

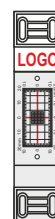

STAMPA TAMPOGRAFICA
PAD PRINTING
TAMPOGRAPHIE

min € 100 **0,15** Promo € 200 **0,10**

10 097 - CRACK FLOOR

Fessurimetro per Piani
Crack Monitor for Plans
Fissurometre pour Planes

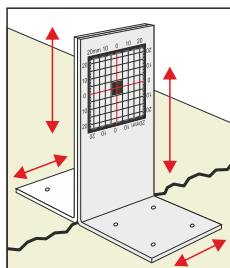
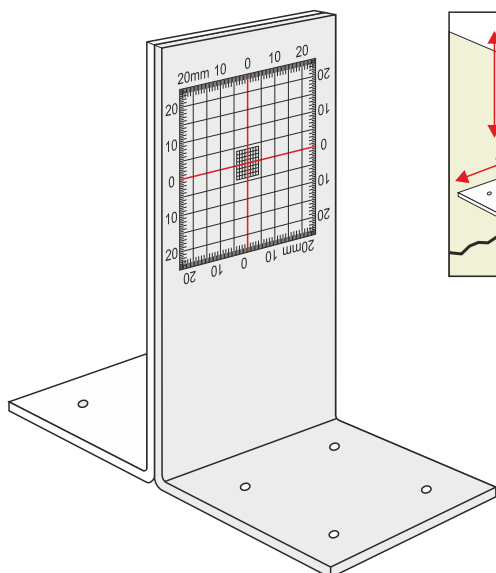

Blister



Il Blister Include:
- Fessurimetro
- Etichette di Posizione
- Tabelle di Rilevazione

Blister Including:
- Crack Monitor
- Labels for Position
- Detection Tables

Le Blister Comprend:
- Fissurometre
- Étiquettes de Position
- Tables de Détection

Art. n. €
10 097 01B 1 5

FESSURIMETRI - CRACK MONITOR - FISSUROMETRES

10 099 - CRACK WALL

Fessurimetro da Parete
Crack Monitor for Walls
Fissurometre pour Murs

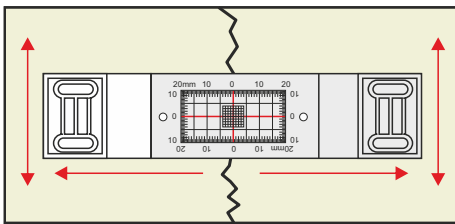
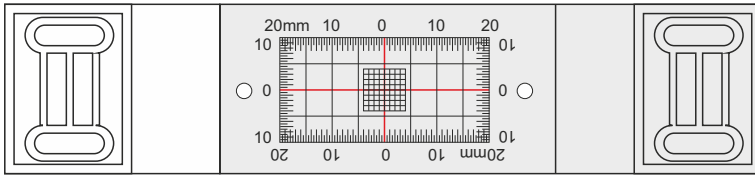

Blister

10 099 01B N.1
10 099 02B N.2
10 099 04B N.4



Scatola
Box
Boîte

10 099 10 N.10

la Confezione Include:
- Fessurimetro
- PERNI di Allineamento
- Etichette di Posizione
- Tabelle di Rilevazione

Packing Including:
- Crack Monitor
- Alignment Pins
- Labels for Position
- Detection Tables

l'Emballage Comprend:
- Fissurometre
- Broches d'Alignement
- Étiquettes de Position
- Tables de Détection

Art.	n.		€
10 099 01B	1	10	
10 099 02B	2	10	
10 099 04B	4	5	
10 099 10	10	1	

10 098 - CRACK CORNER

Fessurimetro Per Angoli
Crack Monitor For Corners
Fissurometre Pour Coin

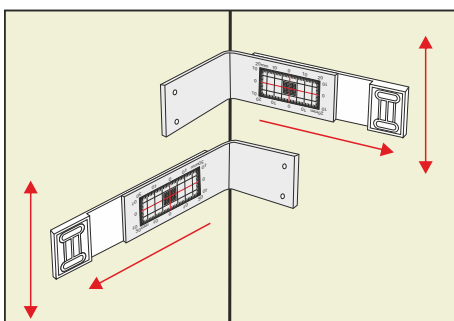
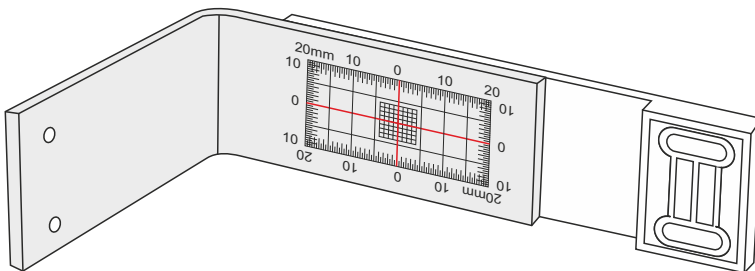

Blister

10 098 01B N.1
10 098 02B N.2



Scatola
Box
Boîte

10 098 04 N.4

la Confezione Include:
- Fessurimetro
- Etichette di Posizione
- Tabelle di Rilevazione

Packing Including:
- Crack Monitor
- Labels for Position
- Detection Tables

l'Emballage Comprend:
- Fissurometre
- Étiquettes de Position
- Tables de Détection

Art.	n.		€
10 098 01B	1	5	
10 098 02B	2	5	
10 098 04	4	1	

FILI EDILIZIA - BRICKLAYER WIRE - CORDEAU TRESSE

16 213 - FILO FLUO

Filo Per Edilizia Extra
High Quality Bricklayer Wire
Cordeau Tresse

INNOVATION
2021



STRONG
Alta Tenacità
High Toughness
Haute Ténacité



HIGH
Alta Visibilità
High Visibility
Haute Visibilité



FLUO

Giallo Fluo, Alta Visibilità, Riflettente Rosso
Yellow Fluo, High Visibility, Reflective Red
Jaune Fluo, Haute Visibilité, Réfléchissant Rouge

	Art.	m	Ø		€
Ø 1,5	16 213 00	100	1,5	15	
	16 213 01	250	1,5	15	
Ø 2,5	16 213 02	100	2,5	15	
	16 213 03	250	2,5	15	

INNOVATION
2021



STRONG
Alta Tenacità
High Toughness
Haute Ténacité



HIGH
Alta Visibilità
High Visibility
Haute Visibilité



FLUO

Arancio Fluo, Alta Visibilità, Riflettente Bianco
Orange Fluo, High Visibility, Reflective White
Orange Fluo, Haute Visibilité, Réfléchissant Blanc

	Art.	m	Ø		€
Ø 2,5	16 214 02	100	2,5	15	
	16 214 03	250	2,5	15	
Ø 3,5	16 214 05	50	3,5	15	
	16 214 06	100	3,5	15	

INNOVATION
2021



STRONG
Alta Tenacità
High Toughness
Haute Ténacité



HIGH
Alta Visibilità
High Visibility
Haute Visibilité



FLUO

Giallo Fluo, Alta Visibilità, Riflettente Bianco
Yellow Fluo, High Visibility, Reflective White
Jaune Fluo, Haute Visibilité, Réfléchissant Blanc

	Art.	m	Ø		€
Ø 1,0	16 215 00	100	1,0	15	
	16 215 01	250	1,0	15	

16 210 - FILO

Filo Da Muratore
Bricklayer Wire
Cordeau Tresse

Treccia in Materiale Sintetico, Antisfilacciamento
Synthetic, Fraying-Proof
En Nylon, Anti-Effilochage



	Art.	m	Ø		€
○	16 210 00	100	1,5	15	
●	16 211 00	100	1,5	15	